

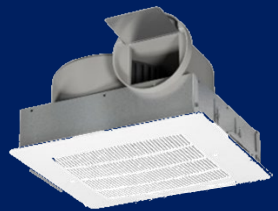

# 2025-26 STOCK CATALOG



## SALES OFFICES

**ALBANY, NEW YORK**  
22 Computer Dr West  
Albany, NY 12205  
(518) 869-3541

**BUFFALO, NEW YORK**  
3242 Union Road  
Cheektowaga, NY 14227  
(716) 276-8933

**ROCHESTER, NEW YORK**  
889 Atlantic Avenue  
Rochester, NY 14609  
(585) 697-0836

**SYRACUSE, NEW YORK**  
6412 Baird Avenue  
Syracuse, NY 13206  
(315) 471-0105

**Warehouse Locations: Buffalo, Rochester & Syracuse**

IMMEDIATE SHIPPING OR PICKUP AVAILABLE •



• [www.rfpeck.com](http://www.rfpeck.com)



**For all equipment use:**

**.65 Multiplier**

plus freight\*

\*If not directly picked up from the warehouse

---

# Table of Contents

<u>Items</u>	<u>Page</u>
Access Doors	15
Brick Vents	15
Ceiling Fan	11
Dampers	14
Diffusers	2,3,4
Equipment Rails	12
Fan Accessories	12
Grilles	5
Heat Pumps	22
Insulated Flex Ducts	21
Louvers	15
Motors	21
Pipe Portals	12
RG&D Accessories	6
Roof Caps	13
Roof Fans	9
Splits & Accessories	23,24
Variable Frequency Drives	18,19
Variable Frequency Drive Parts	20
VAV & Coils	7
Vibration Hangers/Isolators	16,17
Wall Caps	13

## TERMS & CONDITIONS

- Prices:** Prices are F.O.B Albany, Syracuse & Rochester, New York. Prices are subject to change without notice.
- Terms:** All orders are to be paid with either cash, bank approved check, or credit card unless prior credit has been approved. Credit terms to be Net thirty (30) days from date of invoice. A service charge of 1 ½% per month will be charged after thirty (30) days until payment is received. Also reasonable attorneys' fees in the amount of fifteen percent (15%) of outstanding balance shall be assessed in the event it becomes necessary to collect and indebtedness hereunder by or through any attorney-at-law.
- Taxes:** No taxes are included in the sale price.
- Warranty:** R.F. Peck Co., Inc. makes no express warranties as to the goods sold but extends to the buyer the manufacturer's warranty which is available upon request.
- Returns:** No products shall be returned unless *approved in writing* and will be subject to transportation, handling charges and restocking charges.
- Consequential:** R.F. Peck Co., Inc. shall not be liable for any consequential, incidental or contingent Damages whatsoever.

## Supply Diffusers

### RNS3



**Features:**

- Material: Steel
- 3 Concentric Cones
- Appliance White Finish

T-Bar Lay-in			
Panel	Neck Size	CFM Range	List Price
11 ¾ X 11 ¾	6	100-200	\$50.00
	8	200-360	\$50.00
23 ¾ x 23 ¾	6	100-200	\$68.00
	8	200-360	\$68.00
	10	360-550	\$68.00
	12	550-780	\$68.00

### UNI2



**Features:**

- Material: Steel
- Easily Removable Plaque Face
- Appliance White Finish

T-Bar Lay-in			
Panel	Neck Size	CFM Range	List Price
23 ¾ x 23 ¾	6	100-200	\$80.00
	8	200-360	\$80.00
	10	360-550	\$80.00
	12	550-780	\$80.00

## Return Diffusers

### 4360

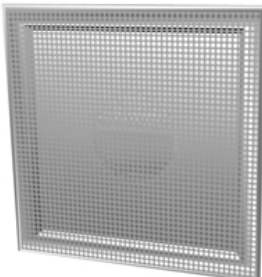

**Features:**

- Material: Steel
- Hinged Removable Perforated Face with Round Neck
- White Finish

T-Bar Lay-in			
Panel	Neck Size	CFM Range	List Price
23 ¾ x 23 ¾	6	175	\$64.00
	8	250	\$64.00
	10	350	\$64.00
	12	400	\$64.00
	22 X 22	3000	\$53.00

## Slot Diffusers

**5710**



**Features:**

- Material
  - Shell – Corrosion resistant steel
  - Pattern Controllers – Extruded Aluminum
  - Blade Gasket - Vinyl
- Blades Factory Installed and Field Adjustable for Left, Right or Vertical Airflows
- 1" slot width
- Lay-in Frame
- White Finish on center T-bars
- Black pattern controllers and exposed surfaces

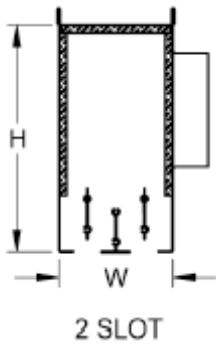

Inlet Dimensions	
Listed Inlet Size	Actual Inlet Dimension
6"	5" - 7/8" Round
8"	7" - 7/8" Round
10"	7" - 7/8" x 11" Oval

Inlet Size	Length	# of Slots	Slot Width	CFM	List Price
6"	24	2	1	50-200	\$100.00
8"	48	2	1	85-360	\$140.00
10"	48	2	1	110-430	\$140.00

**Slot Diffusers**

**61DH-O**

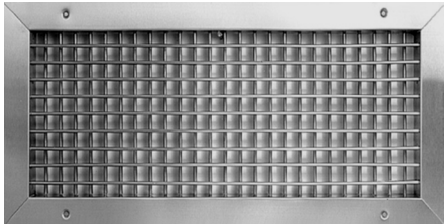

**Features:**

- Material: Steel
- Double Deflection Grille
- Horizontal Front Blades
- Opposed Blade Damper
- White Finish

Surface Mount with Screwholes						
Size	CFM Range	List Price		Size	CFM Range	List Price
6 x 6	55-220	\$49.00		16 x 6	220-840	\$72.00
8 x 6	80-320	\$53.00		16 x 8	245-900	\$82.00
8 x 8	115-470	\$56.00		18 x 6	245-900	\$76.00
10 x 6	100-410	\$58.00		18 x 10	320-1280	\$94.00
10 x 8	140-500	\$61.00		18 x 12	400-1340	\$100.00
10 x 10	180-620	\$67.00		20 x 6	205-750	\$88.00
12 x 6	115-470	\$61.00		20 x 8	245-900	\$90.00
12 x 8	180-610	\$66.00		20 x 10	335-1420	\$100.00
12 x 10	205-800	\$73.00		20 x 12	335-1180	\$110.00
12 x 12	270-920	\$82.00		24 x 6	320-1100	\$94.00
14 x 6	140-500	\$66.00		24 x 8	335-1180	\$105.00
14 x 8	205-750	\$73.00		24 x 10	400-1340	\$115.00
14 x 10	245-970	\$82.00		24 x 12	540-1600	\$130.00

## Return Grilles

**6145H**

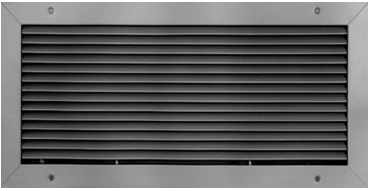

**Features:**

- Material: Steel
- Single Deflection Grille
- Horizontal Front Blades
- White Finish

**Surface Mount with Screwholes**

Size	CFM Range	List Price		Size	CFM Range	List Price
6 x 6	40-120	\$20.00		14 x 14	248-620	\$44.00
8 x 8	76-228	\$26.00		16 x 6	116-348	\$32.00
10 x 6	70-210	\$28.00		16 x 8	162-450	\$35.00
10 x 10	122-305	\$32.00		16 x 10	182-455	\$39.00
12 x 6	84-252	\$28.00		16 x 12	248-620	\$44.00
12 x 8	116-348	\$32.00		16 x 14	274-685	\$49.00
12 x 10	148-370	\$32.00		16 x 16	328-820	\$32.00
12 x 12	180-450	\$35.00		18 x 10	214-642	\$44.00
14 x 6	92-300	\$32.00		18 x 12	274-685	\$44.00
14 x 8	130-325	\$33.00		18 x 18	420-1050	\$66.00
14 x 10	304-760	\$35.00		22 x10 Lay-in	250-700	\$40.00
14 x 12	214-642	\$39.00		22 x22 Lay-in	1000-1400	\$80.00

**61FB45**



**Features:**

- Material: Steel
- Filter Grille used for 1" filters
- 45-degree deflection
- ¼ Turn latch
- Filter not included
- White Finish

T-Bar Lay-in			
Panel	Size	Max CFM	List Price
23 ¾ x 23 ¾	20 x 20 T-Bar	2500	\$140.00

**61EC**

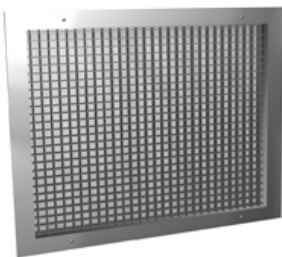

**Features:**

- Material: Aluminum
- Egg Crate Face
- White Finish

**Surface Mount with Screwholes**

Size	CFM Range	List Price
8 x 8	114-380	\$27.00
12 x 12	270-900	\$42.00

**T-Bar Lay-in**

Size	CFM Range	List Price
22 x 10	320-720	\$50.00
22 x 22	620-1200	\$100.00

**PLASTIC**



**Features:**

- Material: Plastic
- Egg Crate Face
- White Finish
- \*Available in the Syracuse Warehouse

**T-Bar Lay-in**

Neck Size	List Price
24 x 24*	\$40.00
48 x 24*	\$55.00

RG&D Accessories

SQ/RD



**Features:**

- Material: Steel
- Fit over diffuser neck
- 3" high square with 3" high collar
- Round neck sizes 1/8" under

Square Dimension	Round Size	List Price
6 x 6	6	\$19.00
8 x 8	6	\$20.00
	8	\$20.00
10 x 10	8	\$21.00
	10	\$21.00
12 x 12	6	\$23.00
	8	\$23.00
	10	\$23.00
	12	\$23.00
18 x 18	16	\$28.00
22 x 10	6	\$30.00
	8	\$30.00
	10	\$30.00
22 x 22	6	\$38.00
	8	\$38.00
	10	\$38.00
	12	\$38.00
	14	\$38.00
	16	\$38.00
	18	\$38.00

DFA

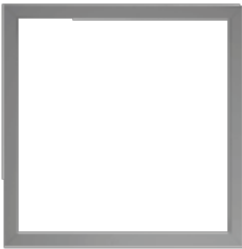

**Features:**

- Material: Aluminum
- For drywall ceilings
- White finish

Size	List Price
12 x 12	\$32.00
24 x 24	\$53.00

## Air Terminal Units & Coils

### D3001



**Features:**

- Material: 22ga galvanized steel housing
- Mechanically sealed & gasketed, leak resistant construction
- Internal fiberglass insulation ¾" dual density (meets NFPA 90a & UL 181 requirements)
- Rectangular discharge opening with slip & drive cleat duct connection
- Fiber Free Lining, Control Enclosure & Access Door
- Gauge taps are standard

Inlet Size	CFM Range	Imperial Units (inches)			List Price
		Outlet	Inlet	Length	
6	0-550	10	10	20 ½	\$370.00
8	0-1100	12	12 ½	20 ½	\$400.00
10	0-1840	14	12 ½	20 ½	\$460.00
12	0-2500	18	12 ½	20 ½	\$480.00
14	0-3125	24	12 ½	20 ½	\$560.00

### 2 Row Coil



Unit Size	Width	Height	MBH*	List Price
6	10	10	15.7	\$260.00
8	12	12 ½	26.4	\$280.00
10	14	12 ½	38.2	\$310.00
12	18	12 ½	52	\$360.00
14	24	12 ½		\$430.00

\* Based on 180° EWT/60° EAT

## Fan Engineering Information

### Recommended Rates of Air Change Per Building Type

	Minute Per Air Change		Minute Per Air Change		Minute Per Air Change		Minute Per Air Change
<b>GENERAL</b>		<b>HOSPITALS</b>		<b>HOTEL</b>		<b>PLANTS/FACTORIES</b>	
Corridors . . . . .	60-20	Disinfecting Room . . . . .	2-5	Dance Hall . . . . .	3-8	General Plant	
Kitchens . . . . .	1-3	Consulting Room . . . . .	2-8	Gallery . . . . .	6-12	Bakeries . . . . .	1-3
Living Rooms . . . . .	2-4	Office Room . . . . .	3-10	Washing Room . . . . .	1-4	Dry Cleaners . . . . .	1-5
Meeting Rooms . . . . .	4-10	Operating Room . . . . .	1-4	<b>MACHINE ROOMS</b>		Foundries . . . . .	1-4
Office . . . . .	2-8	Respiratory . . . . .	2-6	Boiler Room . . . . .	2-4	Glass Plants . . . . .	1-2
Residences . . . . .	2-5	Patients . . . . .	5-10	Compressor Room . . . . .	2-4	Machine Shop . . . . .	3-5
Toilet: Private . . . . .	1-3	Waiting Room . . . . .	4-8	Engine Room . . . . .	1-2	Mills (Paper) . . . . .	2-3
Public . . . . .	2-5	<b>INSTITUTIONAL</b>		Generating Room . . . . .	2-5	Mills (Textiles) . . . . .	5-15
<b>RECREATIONAL</b>		Assembly Hall . . . . .	3-10	Transformer . . . . .	1-5	Shop (General Vent) . . . . .	3-10
Bars . . . . .	2-4	Auditoriums . . . . .	4-15	Turbine Room . . . . .	2-6	Spinning Factory . . . . .	4-12
Bowling Alley . . . . .	2-8	Banks . . . . .	3-10	<b>FOOD STORES</b>		Warehouse . . . . .	2-10
Gymnasium . . . . .	2-10	Churches . . . . .	4-15	Banquet Hall . . . . .	3-6		
Recreational Room . . . . .	2-8	Library . . . . .	5-12	Kitchens . . . . .	1-3		
Theaters . . . . .	3-8			Restaurants . . . . .	5-10		
				Tempura House . . . . .	1-3		

### Methods of Calculating Air Volume

**RATE OF AIR CHANGE METHOD:**

- Step 1. Find total cubic feet of air space within the building or room to be ventilated.
- Step 2. Determine number of air changes required. Generally mandated by local health codes or use above Air Change Table Guide.
- Step 3. CFM required =  $\frac{\text{Building/Room volume in cubic feet}}{\text{Minute/Air Change}}$

**EXAMPLE:**

Paper mill is 30 ft. x 50 ft. with 10 ft. high ceiling.  
 2-3 minutes per air change required for good ventilation.  
 30 ft. x 50 ft. x 10 ft. = 15,000 cubic ft. to be moved every 2 minutes or 7,500 CFM.

### Fan Laws

The fan laws are a series of formulas used to predict the performance of a fan at parameters other than those listed in the multiratings catalog tables.

**FAN LAW # 1:** Effect of varying the fan speed, with the fan size and density remaining constant:

- a. CFM varies as the RPM :  $\frac{CFM_2}{CFM_1} = \frac{RPM_2}{RPM_1}$
- b. SP varies as the RPM<sup>2</sup> :  $\frac{SP_2}{SP_1} = \left[ \frac{RPM_2}{RPM_1} \right]^2$
- c. BHP varies as the RPM<sup>3</sup> :  $\frac{BHP_2}{BHP_1} = \left[ \frac{RPM_2}{RPM_1} \right]^3$

**Fan Law # 2:** Effect of changed density, with the fan size and speed remaining constant:

- a. The CFM does not change :  $CFM_2 = CFM_1$
- b. The SP varies as the density :  $\frac{SP_2}{SP_1} = \frac{d_2}{d_1}$
- c. The BHP varies as the density :  $\frac{BHP_2}{BHP_1} = \frac{d_2}{d_1}$

*Subscript 1 is the catalog rating of selected fan  
 Subscript 2 is the desired rating*

## Roof Fans

### ACE Spun Aluminum Downblast Roof Exhaust Fan with EC Motor



**Features:**

- Direct Drive with EC motor
- Gravity Backdraft Damper included
- NEMA pre-wired disconnect
- Aluminum bird screen
- Speed Controller Pricing on page 12
- Roof curb dimensions on page 10

		0.000" SP		0.125" SP		0.250" SP		0.375" SP		0.500" SP			
Fan Model	HP	RPM	CFM	Sones	CFM	Sones	CFM	Sones	CFM	Sones	CFM	Sones	List Price
70C17DEC	1/20	1725	284	5.0	218	4.3	150	4.0	78	4.0	N/A	N/A	\$1,300.00
100C17DEC	1/4	1725	481	3.9	400	3.8	300	4.1	139	4.4	N/A	N/A	\$1,500.00
120C17DEC	1/2	1725	1107	7.0	1000	6.6	900	6.4	782	5.9	N/A	N/A	\$1,900.00
135C17DEC	3/4	1725	1688	9.3	1596	9.2	1500	9.1	1400	8.9	1250	8.4	\$2,100.00
150C17DEC	1	1650	2243	10.9	2130	10.6	2000	10.2	1870	9.8	1750	9.6	\$2,400.00

## Fan Dimension Information

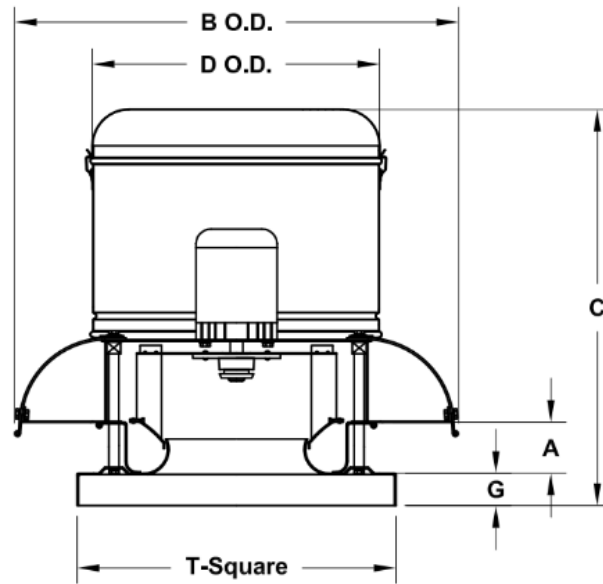

### ACE-D Direct Drive Dimension Data

Size	A	B	C	D	G	T Sq.	Roof Opening Square	Shipping Weight
70	1-3/4	13-5/8	13-13/16	16-3/4	2	18	13-1/2	20
100	2-1/2	18-3/4	16-13/16	16-3/4	2	18	13-1/2	30
120	1-7/16	28-7/16	26-9/16	20-3/8	2	20	15-1/2	67
135	1-15/16	28-7/16	27-1/16	20-3/8	2	20	15-1/2	72
150	2-13/16	32-7/8	29-3/16	23-13/16	2	24	19-1/2	90

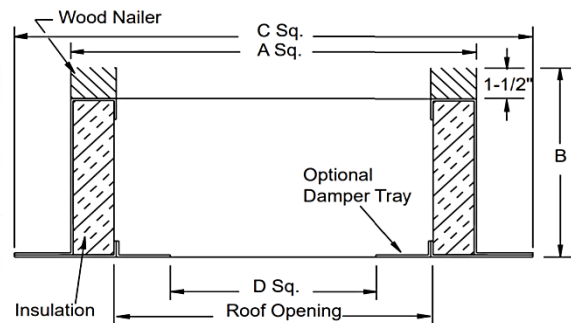

### Roof Curb Dimension Data

Fan Size	A Sq	B	C Sq	D Sq	Roof Opening Square	Curb Size to Order
70-100	16-1/2	9-1/2	20-1/2	9-3/4	13-1/2	17 x 17
120-135	18-1/2	9-1/2	22-1/2	11-3/4	15-1/2	19 x 19
150	22-1/2	9-1/2	26-1/2	15-3/4	19-1/2	23 x 23

\*Pricing on page 9

## Ceiling Fans

### Gemini



**Features:**

- Direct Drive
- Gravity Backdraft Damper included
- Speed Controller Pricing on page 9
- Inline Kits available for GC146, GC148 & GC186
- **GC186-622 Located in Syracuse Warehouse**
- **GC148 Located in Rochester and Syracuse Warehouse**

Model	Motor RPM	0.00"SP CFM/Sones	0.125" SP CFM/Sones	0.250"SP CFM/Sones	0.375"SP CFM/Sones	.500"SP CFM/Sones	0.625"SP CFM/Sones	0.750"SP CFM/Sones	List Price
GC148	1075	152/2.5	142/2.5	132/2.5	120/2.5	108/3.0	94/3.0	78/3.5	\$365.00
GC186	1100	231/5.5	225/5.5	218/5.5	209/5.5	199/5.0	186/5.0	170/5.0	\$470.00
GC542	1600	391/5.5	377/5.5	361/5.5	340/5.5	314/5.5	285/5.0	248/4.5	\$645.00
GC622	1400	501/3.5	486/3.5	461/3.0	433/3.0	392/3.0	339/3.0	-	\$725.00

Model	Inline Kit
GC148	\$70.00
GC186	\$70.00

Model	Speed Controller
GC148	5 amp
GC186	5 amp
GC542	5 amp
GC622	5 amp

## Fan Accessories

### Speed Controller



5 amp      10 amp

#### Features

- Available for Direct Drive units
- Can be mounted remotely or at the unit
- Used to adjust unit to desired capacity
- **5 amp in Rochester & Syracuse Warehouse**
- **10 amp in Syracuse Warehouse only**

Control Mode	List Price
5 amp	\$130.00
10 amp	\$220.00
Reverse Acting T'STAT	\$75.00

### Reverse Acting T'Stat



#### Features:

- Cooling only
- Rough in dims: 4.75"H x 2.9"W x 1.5"D
- Range: 50-90°F
- **\* Available in Rochester Warehouse only**



## Roof Curbs, Equipment Rails & Pipe Portals

### Roof Curbs



#### Features:

- 12" high (*Syracuse*)
- 18" high (*Rochester*)
- 24" high (*Buffalo*)
- Rigid insulation
- Nominal 2" x 2" wood nailer

Curb O.D.	List Price 12"H	List Price 18"H	List Price 24"H
12 x 12	\$155.00	\$170.00	\$200.00
14 x 14	\$175.00	N/A	N/A
16 x 16	\$185.00	N/A	N/A
17 x 17	\$190.00	\$215.00	\$260.00
19 x 19	\$210.00	\$225.00	\$280.00
23 x 23	\$250.00	\$305.00	\$320.00

### Pipe Portals & Pipe Shack



#### Features:

- 12 x 12 x 12"H & 18"H OD Curb – priced separately. (*Rochester*)
- 12 x 12 x 20"H OD Curb – priced separately. (*Buffalo*)
- Plastic Cap, 1 or 4 Pipe Silicone Rubber Boot, Stainless Steel Clamp assembly – priced separately.
- **Pipe Shack** – Side entry 5 port pipes range from 5/8" to 2-7/8"

Size	List Price
1 Pipe Cap Assembly	\$210.00
4 Pipe Cap Assembly	\$210.00
12 x 12 x 12"H Curb	\$155.00
12 x 12 x 18"H Curb	\$170.00
12 X 12 X 24"H Curb	\$200.00
Pipe Shack - 20 x 20 x 20"H Curb with shack & 5 port cover	\$1100.00

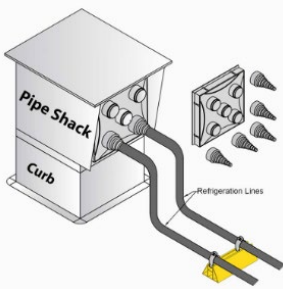

### Rails

#### Features:

- All welded steel support
- 18ga galvanized steel construction
- 12" high & 18"H (*Rochester*)
- 24" high & 18"H (*Buffalo*)
- 2" Flashing Strip
- Factory Installed Wood Nailer



Length	12"H List	18"H List
3 Feet	\$230.00	\$330.00
5 Feet	\$300.00	\$460.00

Length	24"H List
2 Feet	\$240.00
4 Feet	\$400.00
6 Feet	\$620.00

## Wall & Roof Caps

**\*\*Only available in the Syracuse warehouse\*\***

### Wall Caps

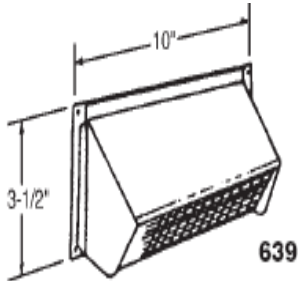

639

- Steel baked black enamel finish
- Spring-loaded backdraft damper and built-in alum bird screen
- For 3 1/2" x 10" duct

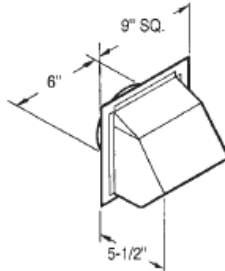

641

- Aluminum – natural finish
- Built-in backdraft damper
- For 6" round duct

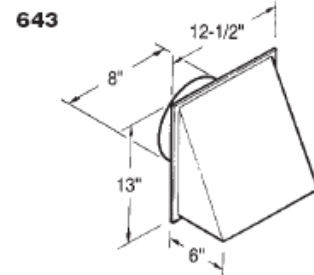

643

- Aluminum – natural finish
- Built-in backdraft damper
- For 8" round duct

Item	List Price
639	\$73.00
641	\$105.00
643	\$180.00

### Roof Caps

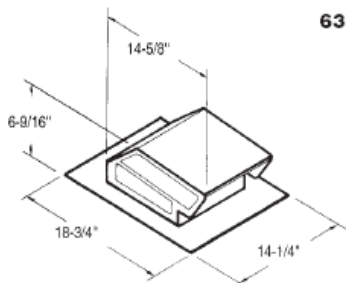

634

- Steel black electrically bonded epoxy finish
- Built-in backdraft damper & birdscreen
- For 10-2/4" x 10 3/4" or up to 10" round

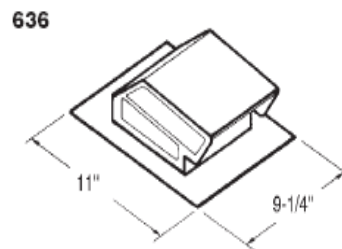

636

- Steel black electrically bonded epoxy finish
- Built-in backdraft damper & birdscreen
- For 3" or 4" round duct

Item	List Price
634	\$80.00
636	\$46.00

## Dampers & Actuators

### VFD10A Fire

**Features:**

- Can be mounted vertically or horizontally
- 1-1/2 hour rated
- Duct size – ¼”
- 4 ½” deep

Size W x H	List Price	Size W x H	List Price
8 x 8	\$49.00	16 x 8	\$63.00
10 x 8	\$49.00	16 x 10	\$74.00
10 x 10	\$54.00	16 x 12	\$74.00
12 x 8	\$52.00	16 x 16	\$82.00
12 x 10	\$52.00	18 x 10	\$82.00
12 x 12	\$58.00	18 x 12	\$82.00
14 x 8	\$63.00	18 x 18	\$98.00
14 x 12	\$74.00	20 x 8	\$74.00
14 x 14	\$82.00	20 x 12	\$82.00

### VFD10C Fire



**Features:**

- Square damper with round transition
- Can be mounted vertically or horizontally
- 1-1/2 hour rated
- Loose links available if needed

Size	List Price
6”	\$110.00
8”	\$110.00
10”	\$120.00
12”	\$130.00

Fusible Links	List Price
165°	\$15.00
210°	\$20.00



### 1020 Control



**Features:**

- 16ga galvanized steel construction
- Blade & jamb seals
- Located in Syracuse Warehouse

Size W x H	List Price	Size W x H	List Price
12 x 12	\$210.00	24 x 12	\$248.00
16 x 16	\$260.00	24 x 16	\$287.00
20 x 20	\$334.00	24 x 24	\$400.00
24 x 10	\$248.00	36 x 24	\$455.00

### 1370 Backdraft



**Features:**

- Blades are roll formed aluminum alloy
- Polyurethane blade seals reduce backflow & noise
- Located in Syracuse Warehouse

Size	List Price
12 x 12	\$150.00
16 x 16	\$180.00
24 x 24	\$272.00

### Belimo



Model	Type	Mounting	Max Sq Ft	Voltage	List Price
LF24	Electric	External/Internal	5-7	24V	\$400.00
LF120	Electric	External/Internal	5-7	120V	\$440.00
NF24	Electric	External/Internal	13-15	24V	\$490.00
NF120	Electric	External/Internal	13-15	120V	\$485.00
½” SHAFT QUAD	Manual				\$21.00

## Louvers & Brick Vents



1604D

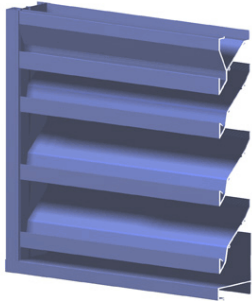

**Features:**

- 4" Deep Louver
- Material: Extruded Aluminum
- 45° Drainable Stationary Blade
- ½" Mesh Aluminum Birdscreen

Size	List Price
12 x 12	\$200.00
16 x 16	\$245.00
24 x 12	\$240.00
24 x 24	\$330.00
36 x 24	\$430.00



168EX



**Features:**

- Brick Vent
- Material: Extruded Aluminum
- ½" Mesh Aluminum Birdscreen

Size	List Price
16½ x 7½	\$240.00

## Access Doors

Cam



**Features:**

- Door Panel – 24ga Galvanized Steel
- Frame – 22ga Galvanized Steel
- Insulation – 1" Fiberglass

Size	List Price
8 x 8	\$40.00
10 x 10	\$44.00
12 x 12	\$49.00
14 x 14	\$58.00
16 x 16	\$72.00
18 x 18	\$82.00
24 x 24	\$115.00

Vibration Isolators

\*Located in Syracuse Warehouse



Model FS-SA  
Spring Mount



Model SHRB  
Spring Hangers



Model SH-SN  
Spring Flex Hangers

Floor Mounted, Spring Type FS-SA				Hangers, Spring Type SHRB				Hangers, Spring Type SH-SN			
Type	Height	Max Load lbs.	List Price	Type	Height	Max Load lbs.	List Price	Type	Height	Max Load lbs.	List Price
FS-SA-45	4 ½"	50	\$80.00	SHRB-2N-50	8"	50	\$137.00	SH-SN-15	4 ½"	23	\$31.00
FS-SA-75	4 ½"	80	\$80.00	SHRB-2N-100	8"	80	\$137.00	SH-SN-45	4 ½"	40	\$31.00
FS-SA-115	4 ½"	130	\$80.00	SHRB-2N-200	8"	130	\$137.00	SH-SN-60	4 ½"	65	\$31.00
FS-SA-200	4 ½"	210	\$80.00	SHRB-2N-200	8"	210	\$137.00	SH-SN-100	4 ½"	90	\$31.00
FS-SA-260	4 ½"	300	\$80.00	SHRB-2N-300	8"	300	\$137.00	SH-SN-150	4 ½"	185	\$31.00
FS-SA-300	4 ½"	370	\$80.00	SHRB-2N-400	8"	370	\$137.00	SH-1N-200	4 ½"	210	\$87.00
								SH-1N-300	4 ½"	300	\$87.00
								SH-1N-300	4 ½"	370	\$87.00

## Vibration Isolators

**\*Located in Syracuse Warehouse**



**Model NH**  
Rubber-In-Shear Hangers



**Model RD**  
Rubber-In-Shear Mounts

Hangers, Rubber-In-Shear Type NH				Floor Mounted, Rubber-In-Shear Type RD			
Type	Height	Max Load lbs.	List Price	Type	Height	Max Load lbs.	List Price
NH-1-30	3"	30	\$21.00	RD-1-Blue	1 ¼"	30	\$32.00
NH-1-60	3"	40	\$21.00	RD-1-Black	1 ¼"	40	\$32.00
NH-1-100	3"	70	\$21.00	RD-1-Red	1 ¼"	70	\$32.00
NH-1-150	3"	120	\$21.00	RD-1-Green	1 ¼"	115	\$32.00
NH-1-200	4"	165	\$21.00	RD-2-Blue	1 ¾"	130	\$45.00
NH-2-300	4"	235	\$45.00	RD-2-Black	1 ¾"	165	\$45.00
NH-2-400	4"	375	\$45.00	RD-2-Red	1 ¾"	235	\$45.00
NH-2-700	4"	572	\$45.00	RD-2-Green	1 ¾"	375	\$45.00

## Shear Flex Pads



### Features:

- Material: Special Rubber
- Extremely High Deflection Rate
- Alternately Raised Ribs provide effective vibration isolation in both high & low load ranges
- Max Load: 60lbs
- Load Range: 15-55 psi

Size	List Price
18" x 18" x 3/8"	\$100.00



**Variable Frequency Drives**



Base Drives				
Voltage	HP	Model	List Price	Stock Location*
208V	2	ACH580-01-07A5-2	\$1,520	S
208V	5	ACH580-01-017A-2	\$1,860	S
208V	10	ACH580-01-031A-2	\$2,640	S
480V	3	ACH580-01-04A8-4	\$1,500	A/S/R
480V	5	ACH580-01-07A6-4	\$1,700	A/S/R
480V	7.5	ACH580-01-012A-4	\$1,900	A/S/R
480V	10	ACH580-01-014A-4	\$2,200	R
480V	15	ACH580-01-023A-4	\$2,800	A/S/R
480V	20	ACH580-01-027A-4	\$3,500	A/S/R
480V	25	ACH580-01-034A-4	\$4,400	R
480V	30	ACH580-01-044A-4	\$5,200	A
480V	40	ACH580-01-052A-4	\$6,300	A
480V	50	ACH580-01-065A-4	\$8,000	A
480V	75	ACH580-01-096A-4	\$8,600	B

**ACH580** General Purpose HVAC Variable Frequency Drive. UL Type I Enclosure, Advanced Operator Keypad, 5% Input Swing Choke (Reactor), EMI/RFI Filter, and embedded N2, FLN, Modbus & BACnet included as standard.

\*Location      **A: Albany**                      **B: Buffalo**                      **S: Syracuse**                      **R: Rochester**  
    22 Computer Dr West      3242 Union Rd                      6412 Baird Avenue                      889 Atlantic Avenue

**Factory Authorized Start-up Not Included\*\***

**Warranty (w/o Factory Authorized Start-up):** 1 year Factory Warranty includes parts only

**\*\*Start Up:** For an additional cost we can provide factory certified start up. Certified start up includes 2 year parts and labor warranty. Please contact your R.F. Peck representative for details





## Variable Frequency Drive Parts

\*Located in Rochester Warehouse



Contactors		
Contactor Voltage: 600V    Coil Voltage: 120V		
Part #	Description	List Price
3AXD50000017471	AX09 – 22 amps	\$220
3AXD50000017472	AX12 – 25 amps	\$265
3AXD50000017473	AX25 – 32 amps	\$265
3AXD50000017474	AX32 – 55 amps	\$310
3AXD50000017475	AX40 – 80 amps	\$310
3AXD50000050428	AX50 – 100 amps	\$360
3AXD50000017477	AX80 – 125 amps	\$595
Fuses		
Part #	Description	List Price
3AU0000015604	15 amps/600V	\$85
3AU0000015605	30 amps/600V	\$88
3AU0000147985	40 amps/600V	\$115
3AU0000015606	60 amps/600V	\$115
3AU0000147987	80 amps/600V	\$140
Cooling Fans		
Part #	Description	List Price
3AXD50000043518	ACH580 R1 Frame	\$120
3AXD50000043519	ACH580 R2 Frame	\$142
3AXD50000030156	ACH580 R3 Frame	\$240
3AXD50000014832	ACH580 R4 Frame	\$240

## Motors

Enclosure	Model	HP	Voltage/Phase	Price
TEFC	EM3546T-G	1	230-460V/3PH	\$940
	EM3554T-G	1.5		\$970
	EM3558T-G	2		\$1,000
	EM3611T-G	3		\$1,120
	EM3615T-G	5		\$1,200
	EM3710T-G	7.5		\$1,680
	EM3714T-G	10		\$1,860
	EM2333T-G	15		\$2,800
	EM2334T-G	20		\$3,340
	EM4103T-G	25		\$4,340
	EM4104T-G	30		\$5,100
	EM4110T-G	40		\$6,600
	EM4115T-G	50		\$7,200
	ODP	EM3116T-G		1
EM3154T-G		1.5	\$980	
EM3157T-G		2	\$1,040	
EM3211T-G		3	\$1,140	
EM3218T-G		5	\$1,230	
EM3311T-G		7.5	\$1,720	
EM3313T-G		10	\$2,050	
EM2513T-G		15	\$2,860	
EM2515T-G		20	\$3,120	
EM2531T-G		25	\$3,840	
EM2535T-G		30	\$4,160	
EM2539T-G		40	\$5,400	
EM2543T-G		50	\$5,900	

- Foot Mounted
- 1800 RPM
- Shaft Grounding
- Class F Insulation
- Rolled Steel



## Insulated Flex Duct



Model	Insulation	Size Round	Price
070RF	R4.2	4"x25'	\$51.30
		6"x25'	\$63.50
		8"x25'	\$75.65
		10"x25'	\$94.60
		12"x25'	\$120.50
		14"x25'	\$146.30

Model	Insulation	Size Round	Price
076RF	R6	4"x25'	\$59.00
		6"x25'	\$71.15
		8"x25'	\$84.85
		10"x25'	\$106.30
		12"x25'	\$139.00
		14"x25'	\$168.30



## Horizontal Water Source Heat Pumps



- Tonnage Range from 1 Ton to 3 Ton with varying voltages and arrangements
- CXM2 Communicating Controls for reduced startup, commissioning, and service time
- Sound-absorbing glass-fiber insulation
- Unique double-isolation compressor mounting for quiet operation
- Field-convertible discharge-air arrangement for horizontal units
- PSC three-speed fan motor
- Eight Standard Safety Features
- Non-corrosive polymer drain pan
- Standard Filter Rail
- **Located in Rochester Warehouse**

Model SC			
Ton	Voltage/Phase	Model	List Price
1	208V/1	SCL012AGC30COPS	\$3,800
1	265V/1	SCL012AEC30COPS	\$3,820
1.5	208V/1	SCL018AGC30COPS	\$4,415
1.5	265V/1	SCL018AEC30COPS	\$4,430
2	230V/1	SCL024AGC30COPS	\$4,600
2	208V-230V/3	SCL024AHC30COPS	\$4,760
2	265V/1	SCL024AEC30COPS	\$4,695
2	460V/3	SCL024AFC30COPS	\$4,780
2.5	230V/1	SCL030AGC30COPS	\$4,700
2.5	208V-230V/3	SCL030AHC30COPS	\$4,920
2.5	265V/1	SCL030AEC30COPS	\$4,860
2.5	460V/3	SCL030AFC30COPS	\$4,960
3	230V/1	SCL036AGC30COPS	\$4,940
3	208V-230/3	SCL036AHC30COPS	\$5,060
3	265V/1	SCL036AEC30COPS	\$5,030
3	460V/3	SCL036AFC30COPS	\$5,090

## Ductless Mini Splits



\*All indoor units are multi-zone compatible

### Cold Climate 1 to 1 Single Zone Heat

Location	BTU's	Voltage/Phase	Price
Indoor	9,000	208-230V/1PH/60Hz	\$1,100
	12,000	208-230V/1PH/60Hz	\$1,150
	18,000	208-230V/1PH/60Hz	\$1,500
	24,000	208-230V/1PH/60Hz	\$1,600
Outdoor	9,000	208-230V/1PH/60Hz	\$2,400
	12,000	208-230V/1PH/60Hz	\$2,440
	18,000	208-230V/1PH/60Hz	\$3,100
	24,000	208-230V/1PH/60Hz	\$3,280

### Standard 1 to 1 Single Zone Heat

Location	BTU's	Voltage/Phase	Price
Indoor	9,000	208-230V/1PH/60Hz	\$640
	12,000	208-230V/1PH/60Hz	\$680
	18,000	208-230V/1PH/60Hz	\$920
	24,000	208-230V/1PH/60Hz	\$1,200
Outdoor	9,000	208-230V/1PH/60Hz	\$1,740
	12,000	208-230V/1PH/60Hz	\$1,760
	18,000	208-230V/1PH/60Hz	\$2,600
	24,000	208-230V/1PH/60Hz	\$2,640



### Cold Climate Multi- Zone Outdoor

Location	BTU's	Voltage/Phase	Price
Outdoor	18,000	208-230V/1PH/60Hz	\$2,900
	24,000	208-230V/1PH/60Hz	\$3,700
	30,000	208-230V/1PH/60Hz	\$4,000
	36,000	208-230V/1PH/60Hz	\$5,500
	42,000	208-230V/1PH/60Hz	\$5,600
	48,000	208-230V/1PH/60Hz	\$6,700

## Ductless Mini Split Accessories

### Linesets – Both Lines Insulated

Size	Feet	Price
1/4 X 3/8 X 1/2	15'	\$215
	25'	\$270
	50'	\$420
1/4 X 1/2 X 1/2	25'	\$280
	50'	\$440
1/4 X 5/8 X 1/2	25'	\$325
	50'	\$490



### Mini Split Condensate Pump

Description	Price
Condensate Pump	\$280



### Stands/Wall Brackets

Description	Price
Stand Small Chassis	\$400
Stand Large Chassis	\$640
Wall Bracket Small Chassis	\$140
Wall Bracket Large Chassis	\$160
XL Bracket w/o Hinge – 500lbs	\$230



### Misc

	Description	Price
Controller	Wired Programmable Controller	\$125
Connectors	1/2in. x 4ft. #10 THHN Wire - Non-Metallic Connectors	\$47
Connectors	3/4in. x 4ft. #8 THHN Wire - Non-Metallic Connectors	\$55
Disconnect	60 amp Non-Fusible Disconnect Switch	\$80
Installation Kit	Includes 60 amp Disconnect, Surge Protector, Whip 1/2" x 4', Wall Sleeve & Quick Coupler SQA Female Adapter	\$260

