



2025-26 STOCK CATALOG



SALES OFFICES

ALBANY, NEW YORK
22 Computer Dr West
Albany, NY 12205
(518) 869-3541

BUFFALO, NEW YORK
3242 Union Road
Cheektowaga, NY 14227
(716) 276-8933

ROCHESTER, NEW YORK
889 Atlantic Avenue
Rochester, NY 14609
(585) 697-0836

SYRACUSE, NEW YORK
6412 Baird Avenue
Syracuse, NY 13206
(315) 471-0105

Warehouse Locations: Buffalo, Rochester & Syracuse

IMMEDIATE SHIPPING OR PICKUP AVAILABLE •



• www.rfpeck.com



For all equipment use:

.65 Multiplier

plus freight*

*If not directly picked up from the warehouse

Rochester Warehouse

889 Atlantic Avenue
Rochester, NY 14609
585-697-0836 phone

**** Located between Culver Road and North Winton in Downtown Rochester ****

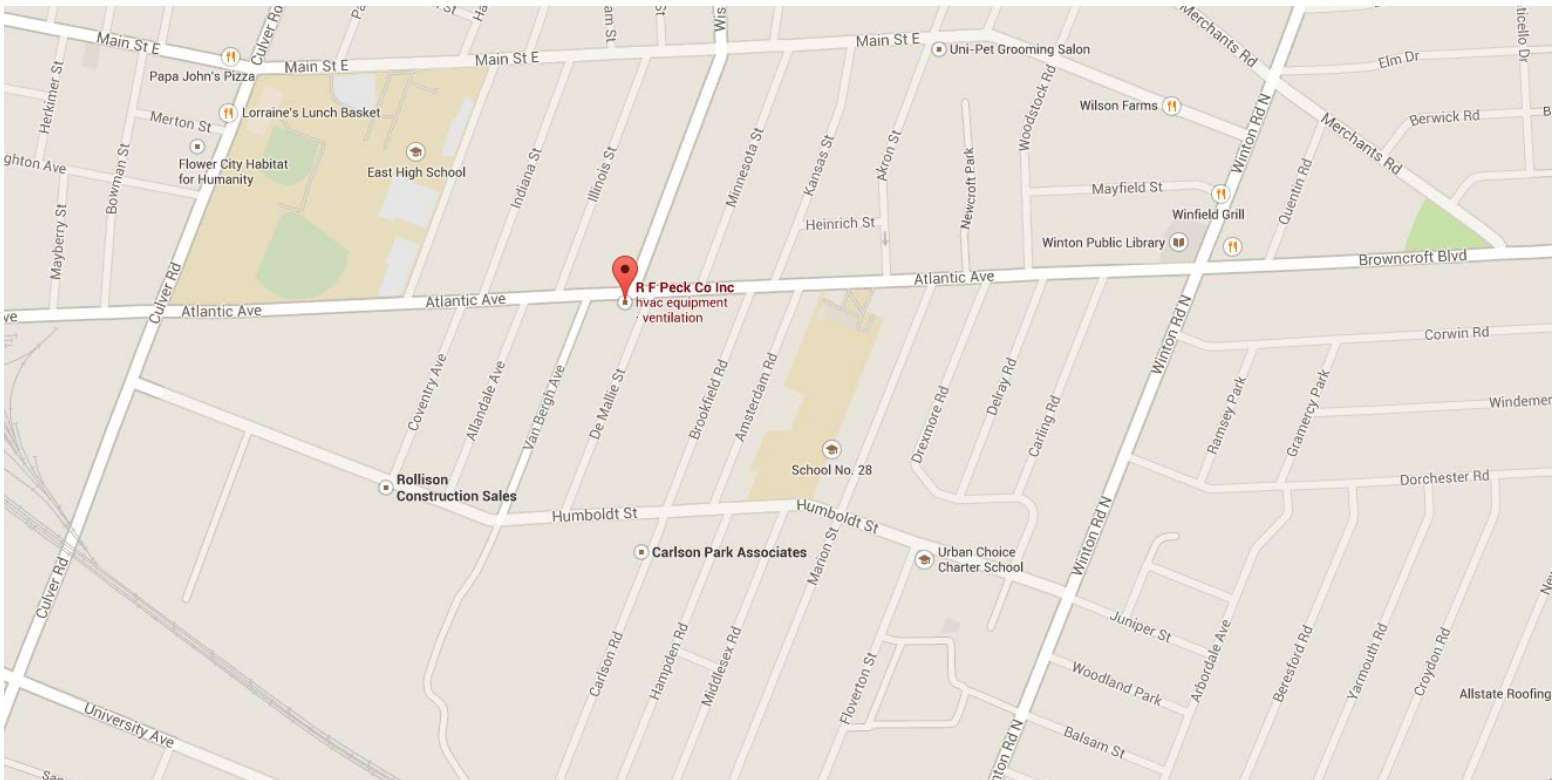

Table of Contents

<u>Items</u>	<u>Page</u>
Ceiling Fan	6
Cooling Tower Parts	10
Diffusers	3
Equipment Rails	6
Fan Accessories	6
Fire Dampers	5
Grilles	3
Heat Pumps	9
Pipe Portals	6
RG&D Accessories	4
Variable Frequency Drives	7
Variable Frequency Drive Parts	11
VAV's & Coils	5

TERMS & CONDITIONS

- Prices:** Prices are F.O.B Rochester, New York. Prices are subject to change without notice.
- Terms:** All orders are to be paid with either cash, bank approved check, or credit card unless prior credit has been approved. Credit terms to be Net thirty (30) days from date of invoice. A service charge of 1 ½% per month will be charged after thirty (30) days until payment is received. Also reasonable attorneys' fees in the amount of fifteen percent (15%) of outstanding balance shall be assessed in the event it becomes necessary to collect and indebtedness hereunder by or through any attorney-at-law.
- Taxes:** No taxes are included in the sale price.
- Warranty:** R.F. Peck Co., Inc. makes no express warranties as to the goods sold but extends to the buyer the manufacturer's warranty which is available upon request.
- Returns:** No products shall be returned unless *approved in writing* and will be subject to transportation, handling charges and restocking charges.
- Consequential:** R.F. Peck Co., Inc. shall not be liable for any consequential, incidental or contingent damages whatsoever

Supply Diffusers

SCD



Features:

- Material: Steel
- 3 Concentric Cones
- Optional Damper (pg. 5)
- White Finish

T-Bar Lay-in

Panel	Neck Size	CFM Range	List Price
11 ¾ x 11 ¾	6	100-200	\$55.00
	8	200-360	\$55.00
23 ¾ x 23 ¾	6	100-200	\$80.00
	8	200-360	\$80.00
	10	360-550	\$80.00
	12	550-780	\$80.00

SPD



Features:

- Material: Steel
- Easily Removable Plaque Face
- Optional Damper (pg. 5)
- White Finish

T-Bar Lay-in

Panel	Neck Size	CFM Range	List Price
23 ¾ x 23 ¾	6	100-200	\$75.00
	8	200-360	\$75.00
	10	360-550	\$75.00
	12	550-780	\$75.00

Return Grilles

530



Features:

- Material: Steel
- Fixed Louvers
- White Finish

T-Bar Lay-in

Neck Size	CFM Range	List Price
22 x 10	320-720	\$63.00
22 x 22	620-1200	\$95.00

RG&D Accessories

VCR8E



Features:

- Material: Steel
- Round Butterfly Damper
- Mounts to diffuser neck

Neck Size	List Price
6	\$27.00
8	\$29.00
10	\$30.00
12	\$31.00

SQ/RD

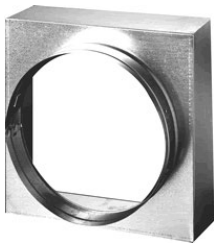

Features:

- Material: Steel
- Fit over diffuser neck
- 3" high square with 3" high collar
- Round neck sizes 1/8" under

Square Dimension	Round Size	List Price
12 x 12	6	\$23.00
	8	\$23.00
	10	\$23.00
	12	\$23.00
22 x 10	6	\$30.00
	8	\$30.00
	10	\$30.00
22 x 22	6	\$38.00
	8	\$38.00
	10	\$38.00
	12	\$38.00

SPF

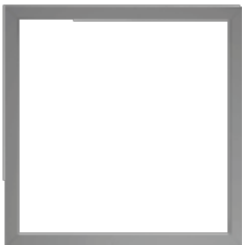

Features:

- Material: Steel
- For drywall ceilings

Size	List Price
12 x 12	\$40.00
24 x 24	\$55.00

Air Terminal Units & Coils

SDV



Features:

- Material: 22ga zinc coated steel housing
- Mechanically sealed & gasketed, leak resistant construction
- Internal insulation ¾" dual density (meets NFPA 90a & UL 181 requirements)
- Rectangular discharge opening with slip & drive cleat duct connection
- Fiber Free Lining & Control Enclosure
- Gauge taps are standard

Inlet Size	CFM Range	Imperial Units (inches)			List Price	
		Outlet		Inlet		Length
6	0-450	12	8	6	20 1/8	\$400.00
8	0-800	12	10	8	20 1/8	\$470.00
10	0-1350	14	12 ½	10	20 1/8	\$500.00
12	0-2150	16	15	12	20 1/8	\$510.00

2 Row Coil



Unit Size	Width	Height	MBH*	List Price
6	12	8	15.7	\$360.00
8	12	10	26.4	\$380.00
10	14	12 ½	38.2	\$430.00
12	16	15	52	\$515.00

* Based on 180° EWT/60° EAT

Ceiling Fans

Gemini



Features:

- Direct Drive
- Gravity Backdraft damper included
- Speed Controller available (below)

Model	Motor RPM	0.00"SP CFM/Sones	0.125" SP CFM/Sones	0.250"SP CFM/Sones	0.375"SP CFM/Sones	.500"SP CFM/Sones	0.625"SP CFM/Sones	0.750"SP CFM/Sones	List Price
GC148	1075	152/2.5	142/2.5	132/2.5	120/2.5	108/3.0	94/3.0	78/3.5	\$365.00

Speed Controller



Device	Control Mode	List Price
Speed Controller	5 amp	\$130.00
Reverse T'stat	Cooling only	\$75.00

Reverse Acting T'Stat



Features:

- Available for Direct Drive units
- Can be mounted remotely or at the unit
- Used to adjust unit to desired capacity

Features:

- Cooling Only
- Rough in dims: 4.75"H x 2.9"W x 1.5"D
- Range: 50-90°F



Equipment Rails, Pipe Portals & Roof Curbs

Rails



Features:

- All welded steel support
- 18ga galvanized steel construction
- 12" & 18" high
- 2" Flashing Strip
- Factory Installed Wood Nailer

Length	12"H List	18"H List
3 Feet	\$230.00	\$330.00
5 Feet	\$300.00	\$460.00

Roof Curbs



Features:

- 18" high
- Rigid insulation
- Nominal 2" x 2" wood nailer

Curb O.D.	List Price
12 x 12	\$170.00
17 x 17	\$215.00
19 x 19	\$225.00
23 x 23	\$305.00

Pipe Portals



Features:

- 12 x 12 x 12"H & 18"H OD Curb – *priced separately*
- Plastic Cap, 1 or 4 Pipe Silicone Rubber Boot, Stainless Steel Clamp assembly – *priced separately*

Size	List Price
1 Pipe Cap Assembly	\$210.00
4 Pipe Cap Assembly	\$210.00
12 x 12 x 12"H Curb	\$155.00
12 x 12 x 18"H Curb	\$170.00



Variable Frequency Drives



Base Drives				
Voltage	HP	Model	List Price	Stock Location*
208V	2	ACH580-01-07A5-2	\$1,520	S
208V	5	ACH580-01-017A-2	\$1,860	S
208V	10	ACH580-01-031A-2	\$2,640	S
480V	3	ACH580-01-04A8-4	\$1,500	A/S/R
480V	5	ACH580-01-07A6-4	\$1,700	A/S/R
480V	7.5	ACH580-01-012A-4	\$1,900	A/S/R
480V	10	ACH580-01-014A-4	\$2,200	R
480V	15	ACH580-01-023A-4	\$2,800	A/S/R
480V	20	ACH580-01-027A-4	\$3,500	A/S/R
480V	25	ACH580-01-034A-4	\$4,400	R
480V	30	ACH580-01-044A-4	\$5,200	A
480V	40	ACH580-01-052A-4	\$6,300	A
480V	50	ACH580-01-065A-4	\$8,000	A
480V	75	ACH580-01-096A-4	\$8,600	B

ACH580 General Purpose HVAC Variable Frequency Drive. UL Type I Enclosure, Advanced Operator Keypad, 5% Input Swing Choke (Reactor), EMI/RFI Filter, and embedded N2, FLN, Modbus & BACnet included as standard.

*Location **A: Albany** **B: Buffalo** **S: Syracuse** **R: Rochester**
 22 Computer Dr West 3242 Union Rd 6412 Baird Avenue 889 Atlantic Avenue

Factory Authorized Start-up Not Included**

Warranty (w/o Factory Authorized Start-up): 1 year Factory Warranty includes parts only

****Start Up:** For an additional cost we can provide factory certified start up. Certified start up includes 2 year parts and labor warranty. Please contact your R.F. Peck representative for details



Variable Frequency Drives



Drives with Bypass, Circuit Breaker and Service Switch				
Voltage	HP	Model	List Price	Stock Location*
480V	3	ACH580-VCR-04A8-4+F267	\$3,400	A/S/R
480V	5	ACH580-VCR-07A6-4+F267	\$3,635	R
480V	7.5	ACH580-VCR-012A-4+F267	\$3,800	A/S/R
480V	10	ACH580-VCR-014A-4+F267	\$4,075	R
480V	15	ACH580-VCR-023A-4+F267	\$4,740	A/S/R
480V	20	ACH580-VCR-027A-4+F267	\$5,640	A/S/R
480V	25	ACH580-VCR-034A-4+F267	\$6,640	R
480V	30	ACH580-VCR-044A-4+F267	\$7,040	B
480V	40	ACH580-VCR-052A-4+F267	\$8,080	B
480V	50	ACH580-VCR-065A-4+F267	\$10,240	B
480V	75	ACH580-BCR-096A-4+F267	\$15,640	B

ACH580 UH Drive with E-Clipse Bypass, UL Type I Enclosure, Main Circuit Breaker, Operator Advanced Bypass Keypad, Output & Bypass Contractors, Drive Input Service Switch, Pass Through Bypass I/O including N2, FLN, Modbus & BACnet included as standard



Drives with Circuit Breaker				
Voltage	HP	Model	List Price	Stock Location*
480V	3	ACH580-PCR-04A8-4	\$2,520	B
480V	5	ACH580-PCR-07A6-4	\$2,740	B
480V	7.5	ACH580-PCR-012A-4	\$2,880	B
480V	10	ACH580-PCR-014A-4	\$3,160	B
480V	15	ACH580-PCR-023A-4	\$3,780	B
480V	20	ACH580-PCR-027A-4	\$4,540	B
480V	25	ACH580-PCR-034A-4	\$5,480	B

ACH580 Drive with UL Type I Enclosure, Main Circuit Breaker, Operator Advanced Bypass Keypad, including N2, FLN, Modbus & BACnet included as standard

*Location **A: Albany** **B: Buffalo** **S: Syracuse** **R: Rochester**
 22 Computer Dr West 3242 Union Rd 6412 Baird Avenue 889 Atlantic Avenue

Factory Authorized Start-up Not Included**

Warranty (w/o Factory Authorized Start-up): 1 year Factory Warranty includes parts only

****Start Up:** For an additional cost we can provide factory certified start up. Certified start up includes 2 year parts and labor warranty. Please contact your R.F. Peck representative for details



Horizontal Water Source Heat Pumps



- Tonnage Range from 1 Ton to 3 Ton with varying voltages and arrangements
- CXM2 Communicating Controls for reduced startup, commissioning, and service time
- Sound-absorbing glass-fiber insulation
- Unique double-isolation compressor mounting for quiet operation
- Field-convertible discharge-air arrangement for horizontal units
- PSC three-speed fan motor
- Eight Standard Safety Features
- Non-corrosive polymer drain pan
- Standard Filter Rail

Model SC			
Ton	Voltage/Phase	Model	List Price
1	208V/1	SCL012AGC30COPS	\$3,800
1	265V/1	SCL012AEC30COPS	\$3,820
1.5	208V/1	SCL018AGC30COPS	\$4,415
1.5	265V/1	SCL018AEC30COPS	\$4,430
2	230V/1	SCL024AGC30COPS	\$4,600
2	208V-230V/3	SCL024AHC30COPS	\$4,760
2	265V/1	SCL024AEC30COPS	\$4,695
2	460V/3	SCL024AFC30COPS	\$4,780
2.5	230V/1	SCL030AGC30COPS	\$4,700
2.5	208V-230V/3	SCL030AHC30COPS	\$4,920
2.5	265V/1	SCL030AEC30COPS	\$4,860
2.5	460V/3	SCL030AFC30COPS	\$4,960
3	230V/1	SCL036AGC30COPS	\$4,940
3	208V-230/3	SCL036AHC30COPS	\$5,060
3	265V/1	SCL036AEC30COPS	\$5,030
3	460V/3	SCL036AFC30COPS	\$5,090



Cooling Tower Parts



Float Parts		
Part #	Description	List Price
006-00004P	Float Ball	\$345
006-00097P	Float Ball	\$185
006-00344P	Float Valve	\$825
006-00390P	Float Valve	\$500
034-00401SA	Float Valve Assembly	\$1,625
030-00248SA	Float Valve Assembly	\$1,130
Pump Parts		
Part #	Description	List Price
010-00018P	Pump Seal Kit	\$870
010-01074P	Pump Repair Kit	\$1,675
010-01075P	Pump Repair Kit	\$1,185
010-01076P	Pump Repair Kit	\$1,240
010-01077P	Pump Repair Kit	\$1,275
Bearing Kits		
Part #	Description	List Price
GT-6	Bearing Kit	\$655
GT-7	Bearing Kit	\$1,170
GT-9	Bearing Kit	\$430
GT-10	Bearing Kit	\$845
GT-12	Bearing Kit	\$1,260
Miscellaneous		
Part #	Description	List Price
016-00001PA	Access Door Gasket	\$70
007-00183P	Caulk	\$70
007-00301P	Sealer Tape	\$77

Variable Frequency Drive Parts



Contactors		
Contactor Voltage: 600V Coil Voltage: 120V		
Part #	Description	List Price
3AXD50000017471	AX09 – 22 amps	\$220
3AXD50000017472	AX12 – 25 amps	\$265
3AXD50000017473	AX25 – 32 amps	\$265
3AXD50000017474	AX32 – 55 amps	\$310
3AXD50000017475	AX40 – 80 amps	\$310
3AXD50000050428	AX50 – 100 amps	\$360
3AXD50000017477	AX80 – 125 amps	\$595
Fuses		
Part #	Description	List Price
3AU0000015604	15 amps/600V	\$85
3AU0000015605	30 amps/600V	\$88
3AU0000147985	40 amps/600V	\$115
3AU0000015606	60 amps/600V	\$115
3AU0000147987	80 amps/600V	\$140
Cooling Fans		
Part #	Description	List Price
3AXD50000043518	ACH580 R1 Frame	\$120
3AXD50000043519	ACH580 R2 Frame	\$142
3AXD50000030156	ACH580 R3 Frame	\$240
3AXD50000014832	ACH580 R4 Frame	\$240

Syracuse Warehouse

6412 Baird Avenue
Syracuse, NY 13206
315-471-0105 phone
315-471-2045 fax

**** Warehouse entrance is on North Ave., off of New Court Ave. on backside of building ****

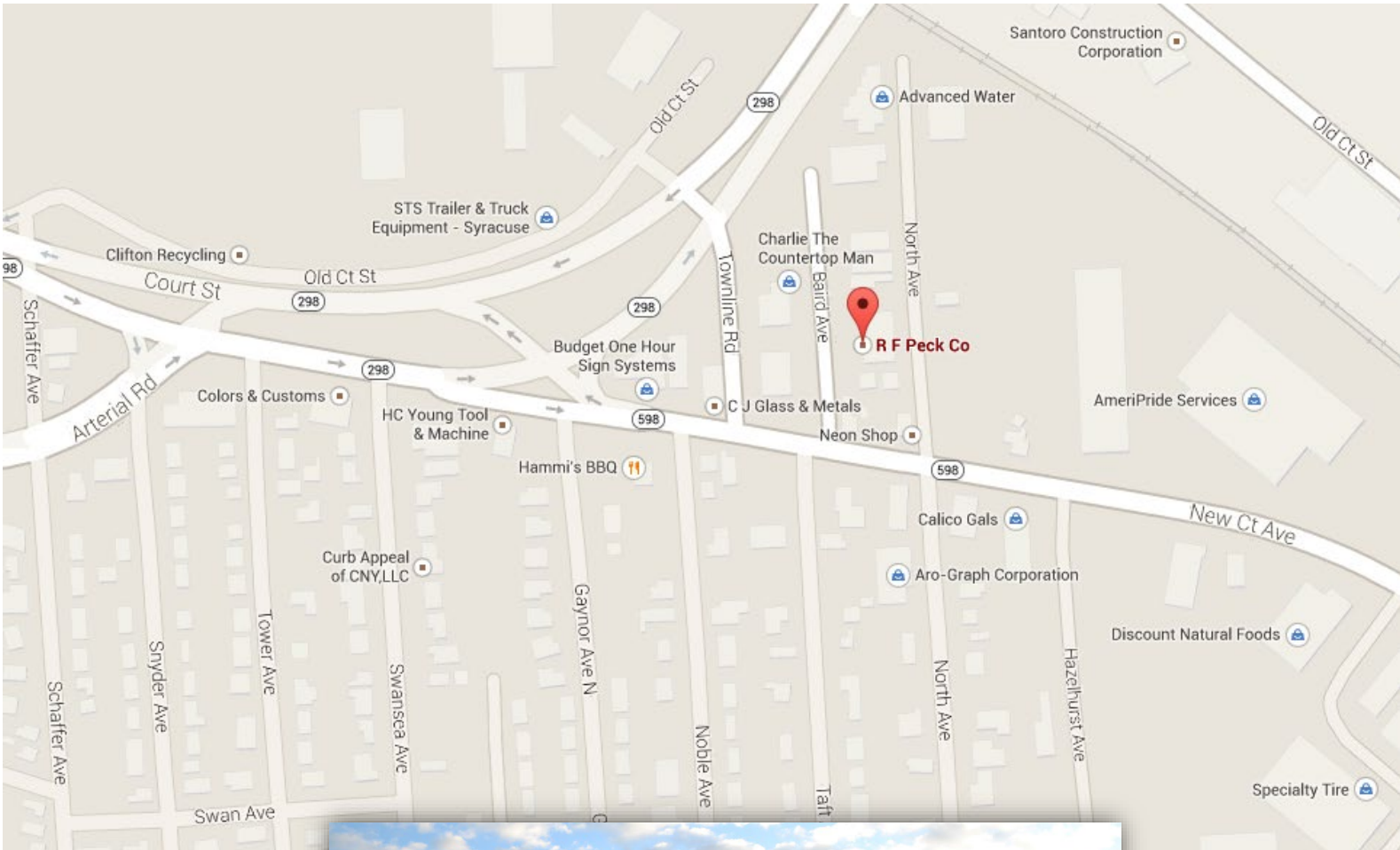

Table of Contents

<u>Items</u>	<u>Page</u>
Actuators	24
Brick Vents	25
Dampers	24
Diffusers	14,15
Ceiling Fans	22
Fan Accessories	23
Fan Dimensions	21
Fan Engineering Information	19
Grilles	16,17
Louvers	25
RG&D Accessories	18
Roof Fans	20
Vibration Hangers/Isolators	26,27
Wall & Roof Caps	23

TERMS & CONDITIONS

- Prices:** Prices are F.O.B Syracuse, New York. Prices are subject to change without notice.
- Terms:** All orders are to be paid with either cash, bank approved check, or credit card unless prior credit has been approved. Credit terms to be Net thirty (30) days from date of invoice. A service charge of 1 ½% per month will be charged after thirty (30) days until payment is received. Also reasonable attorneys' fees in the amount of fifteen percent (15%) of outstanding balance shall be assessed in the event it becomes necessary to collect and indebtedness hereunder by or through any attorney-at-law.
- Taxes:** No taxes are included in the sale price.
- Warranty:** R.F. Peck Co., Inc. makes no express warranties as to the goods sold but extends to the buyer the manufacturer's warranty which is available upon request.
- Returns:** No products shall be returned unless *approved in writing* and will be subject to transportation, handling charges and restocking charges.
- Consequential:** R.F. Peck Co., Inc. shall not be liable for any consequential, incidental or contingent damages whatsoever

Supply Diffusers

SCD



Features:

- Material: Steel
- 3 Concentric Cones
- Optional Damper (pg. 17)
- White Finish

T-Bar Lay-in			
Panel	Neck Size	CFM Range	List Price
11 ¾ x 11 ¾	6	100-200	\$58.00
	8	200-360	\$58.00
23 ¾ x 23 ¾	6	100-200	\$80.00
	8	200-360	\$80.00
	10	360-550	\$80.00
	12	550-780	\$80.00
	14	780-1200	\$80.00

Return Diffusers

PDDR

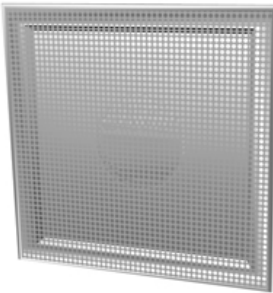

Features:

- Material: Steel
- Hinged Removable Perforated Face with Round Neck
- Optional Round Damper (pg. 17)
- White Finish

T-Bar Lay-in			
Panel	Neck Size	CFM Range	List Price
23 ¾ x 23 ¾	6	100-200	\$70.00
	8	200-360	\$70.00
	10	360-550	\$70.00
	12	550-780	\$70.00
	14	518-1036	\$70.00
	16	736-1227	\$95.00
23 ¾ x 11 ¾	22 x 10	1375	\$73.00
23 ¾ x 23 ¾	22 x 22	3000	\$67.00

PFRF

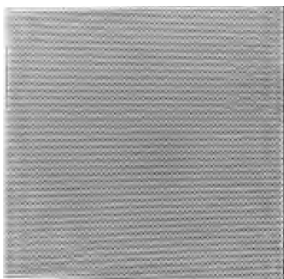

Features:

- Material: Steel
- Perforated Ceiling Panel
- Non-ducted Return
- White Finish

T-Bar Lay-in			
Panel/Face	Neck Size	CFM Range	List Price
11 ¾ x 11 ¾	10 x 10	840	\$30.00
23 ¾ x 11 ¾	22 x 10	1375	\$38.00
23 ¾ x 23 ¾	22 x 22	3000	\$50.00

Slot Diffusers

TBDI4100



Features:

- Material
 - Shell – Coated Steel
 - Pattern Controllers – Extruded Aluminum
 - Blade Gasket - Vinyl
- Blades Factory Installed and Field Adjustable for Left, Right or Vertical Airflows
- Spring Rotates up for Blade Removal
- Internal Insulation
- 1" slot width
- Lay-in Frame
- White Finish

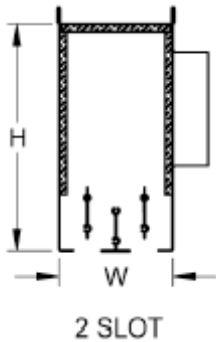

Inlet Dimensions			
Listed Inlet Size	Actual Inlet Dimension	W	H
8"	4" x 10.125" Oval	4"	8"

Inlet Size	Length	# of Slots	Slot Width	CFM	List Price	List Price w/ Auxiliary Frame
8	48	2	1	164-707	\$256.00	\$280.00

Supply Grilles

520D

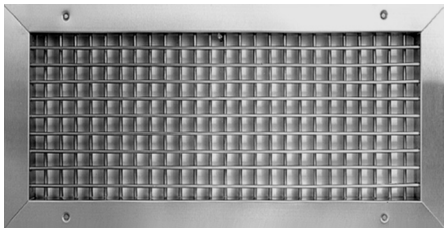

Features:

- Material: Steel
- Double Deflection Grille
- Horizontal Front Blades
- Opposed Blade Damper
- White Finish

Surface Mount with Screwholes

Size	CFM Range	List Price	Size	CFM Range	List Price
6 x 6	55-220	\$69.00	16 x 6	220-840	\$92.00
8 x 4	170-275	\$61.00	16 x 8	245-900	\$106.00
8 x 6	80-320	\$71.00	16 x 10	270-1080	\$115.00
8 x 8	115-470	\$75.00	16 x 12	335-1180	\$126.00
10 x 4	250-350	\$69.00	16 x 16	480-1500	\$160.00
10 x 6	100-410	\$71.00	18 x 6	245-900	\$101.00
10 x 8	140-500	\$80.00	18 x 10	320-1280	\$121.00
10 x 10	180-620	\$85.00	18 x 12	400-1340	\$135.00
12 x 4	100-410	\$75.00	20 x 6	205-750	\$106.00
12 x 6	115-470	\$78.00	20 x 8	245-900	\$119.00
12 x 8	180-610	\$92.00	20 x 10	335-1420	\$129.00
12 x 10	205-800	\$99.00	20 x 12	335-1180	\$142.00
12 x 12	270-920	\$106.00	24 x 6	320-1100	\$114.00
14 x 6	140-500	\$87.00	24 x 8	335-1180	\$135.00
14 x 8	205-750	\$96.00	24 x 10	400-1340	\$150.00
14 x 10	245-970	\$108.00	24 x 12	540-1600	\$169.00

Return Grilles

530

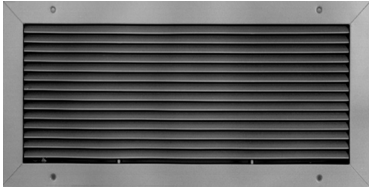

Features:

- Material: Steel
- Single Deflection Grille
- Horizontal Front Blades
- White Finish

Surface Mount with Screwholes					
Size	CFM Range	List Price	Size	CFM Range	List Price
6 x 6	36-150	\$37.00	16 x 8	162-450	\$52.00
8 x 6	52-200	\$37.00	16 x 10	182-455	\$56.00
8 x 8	78-250	\$37.00	16 x 12	236-600	\$60.00
10 x 6	68-230	\$36.00	16 x 16	320-780	\$67.00
10 x 8	92-300	\$44.00	18 x 10	214-642	\$60.00
10 x 10	120-360	\$48.00	18 x 12	268-670	\$63.00
12 x 6	78-250	\$44.00	18 x 18	380-840	\$75.00
12 x 8	120-360	\$44.00	22 x10 Lay-in	250-700	\$65.00
12 x 10	138-483	\$48.00	22 x22 Lay-in	1000-1400	\$95.00
12 x 12	182-500	\$52.00	24 x 10	268-670	\$67.00
14 x 6	92-300	\$44.00	24 x 12	360-840	\$69.00
14 x 8	138-400	\$48.00	24 x 14	416-1040	\$78.00
14 x 10	162-486	\$52.00	24 x 16	490-1225	\$81.00
14 x 12	214-642	\$56.00	24 x 24	1083-1450	\$106.00
14 x 14	236-600	\$60.00	36 x 24	1116-1900	\$150.00

530FF



Features:

- Material: Steel
- Filter Grille used for 1" filters
- Face fits inside frame
- Removable Face
- Positive Locking Latch
- Filter not included
- White Finish

T-Bar Lay-in			
Panel	Size	Max CFM	List Price
23 ¾ x 23 ¾	20 x 20 T-Bar	2500	\$210.00

80

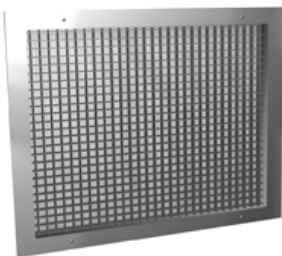

Features:

- Material: Aluminum
- Egg Crate Face
- White Finish

Surface Mount with Screwholes		
Size	CFM Range	List Price
12 x 12	270-750	\$57.00
24 x 24	620-1200	\$130.00
T-Bar Lay-in		
Size	CFM Range	List Price
22 x 10	320-720	\$73.00
22 x 22	620-1200	\$115.00

80PL

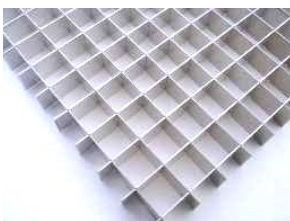

Features:

- Material: Plastic
- Egg Crate Face
- White Finish

T-Bar Lay-in	
Neck Size	List Price
24 x 24	\$40.00
48 x 24	\$55.00

VCR8E



Features:

- Material: Steel
- Round Butterfly Damper
- Mounts to diffuser neck

Neck Size	List Price
6	\$27.00
8	\$29.00
10	\$30.00
12	\$31.00
14	\$50.00

SQ/RD

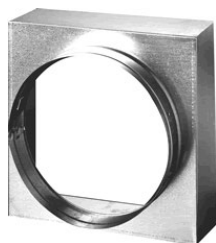

Features:

- Material: Steel
- Fit over diffuser neck
- 3" high square with 3" high collar
- Round neck sizes 1/8" under

Square Dimension	Round Size	List Price
6 x 6	6	\$19.00
8 x 8	6	\$20.00
	8	\$20.00
10 x 10	8	\$21.00
	10	\$21.00
12 x 12	10	\$23.00
	12	\$23.00
18 x 18	16	\$28.00
	14	\$34.00
22 X 22	16	\$34.00
	18	\$34.00

SPF

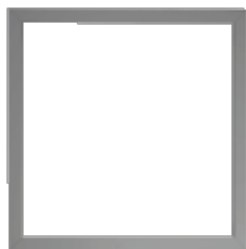

Features:

- Material: Steel
- For drywall ceilings
- White finish

Size	List Price
12 x 12	\$40.00
24 x 24	\$55.00

Fan Engineering Information

Recommended Rates of Air Change Per Building Type

	Minute Per Air Change		Minute Per Air Change		Minute Per Air Change		Minute Per Air Change
GENERAL		HOSPITALS		HOTEL		PLANTS/FACTORIES	
Corridors	60-20	Disinfecting Room	2-5	Dance Hall	3-8	General Plant	
Kitchens	1-3	Consulting Room	2-8	Gallery	6-12	Bakeries	1-3
Living Rooms	2-4	Office Room	3-10	Washing Room	1-4	Dry Cleaners	1-5
Meeting Rooms	4-10	Operating Room	1-4	MACHINE ROOMS		Foundries	1-4
Office	2-8	Respiratory	2-6	Boiler Room	2-4	Glass Plants	1-2
Residences	2-5	Patients	5-10	Compressor Room	2-4	Machine Shop	3-5
Toilet: Private	1-3	Waiting Room	4-8	Engine Room	1-2	Mills (Paper)	2-3
Public	2-5	INSTITUTIONAL		Generating Room	2-5	Mills (Textiles)	5-15
RECREATIONAL		Assembly Hall	3-10	Transformer	1-5	Shop (General Vent)	3-10
Bars	2-4	Auditoriums	4-15	Turbine Room	2-6	Spinning Factory	4-12
Bowling Alley	2-8	Banks	3-10	FOOD STORES		Warehouse	2-10
Gymnasium	2-10	Churches	4-15	Banquet Hall	3-6		
Recreational Room	2-8	Library	5-12	Kitchens	1-3		
Theaters	3-8			Restaurants	5-10		
				Tempura House	1-3		

Methods of Calculating Air Volume

RATE OF AIR CHANGE METHOD:

- Step 1. Find total cubic feet of air space within the building or room to be ventilated.
- Step 2. Determine number of air changes required. Generally mandated by local health codes or use above Air Change Table Guide.
- Step 3. CFM required = $\frac{\text{Building/Room volume in cubic feet}}{\text{Minute/Air Change}}$

EXAMPLE:

Paper mill is 30 ft. x 50 ft. with 10 ft. high ceiling.
 2-3 minutes per air change required for good ventilation.
 30 ft. x 50 ft. x 10 ft. = 15,000 cubic ft. to be moved every 2 minutes or 7,500 CFM.

Fan Laws

The fan laws are a series of formulas used to predict the performance of a fan at parameters other than those listed in the multiratings catalog tables.

FAN LAW # 1: Effect of varying the fan speed, with the fan size and density remaining constant:

- a. CFM varies as the RPM : $\frac{CFM_2}{CFM_1} = \frac{RPM_2}{RPM_1}$
- b. SP varies as the RPM² : $\frac{SP_2}{SP_1} = \left[\frac{RPM_2}{RPM_1} \right]^2$
- c. BHP varies as the RPM³ : $\frac{BHP_2}{BHP_1} = \left[\frac{RPM_2}{RPM_1} \right]^3$

Fan Law # 2: Effect of changed density, with the fan size and speed remaining constant:

- a. The CFM does not change : $CFM_2 = CFM_1$
- b. The SP varies as the density : $\frac{SP_2}{SP_1} = \frac{d_2}{d_1}$
- c. The BHP varies as the density : $\frac{BHP_2}{BHP_1} = \frac{d_2}{d_1}$

*Subscript 1 is the catalog rating of selected fan
 Subscript 2 is the desired rating*

Roof Fans

ACE Spun Aluminum Downblast Roof Exhaust Fan



Features:

- Direct Drive
- Gravity Backdraft Damper included
- Speed Controller Pricing on page 13
- Roof curb dimensions on page 11

Fan Model	HP	RPM	Tip Speed	0.000" SP		0.125" SP		0.250" SP		0.375" SP		0.500" SP		Speed Control	List Price	w/ curb
				CFM	Sones	CFM	Sones	CFM	Sones	CFM	Sones	CFM	Sones			
70C15DL	1/20	1700	3112	171	5.35	131	5.0	113	4.8	91	4.7	-		5 amp	\$875.00	\$1,065.00
70C15DM	1/20	1670	3057	242	5.9	187	5.6	157	5.2	102	4.6	-		5 amp	\$875.00	\$1,065.00
70C15DH	1/20	1550	2837	305	5.2	249	5.2	194	5.1	135	5.0	-		5 amp	\$835.00	\$1,025.00
90C15DM	1/8	1670	3841	658	9.5	600	9.0	564	8.5	469	8.5	412	7.9	5 amp	\$960.00	\$1,150.00
100C15DL	1/8	1665	4362	583	11.3	545	11.1	505	10.9	467	10.6	427	10.3	5 amp	\$970.00	\$1,160.00
150C13D	3/4	1300	5105	2720	15.3	2624	15.3	2527	15.3	2427	15.1	2322	14.9	10 amp	\$1,790.00	\$2,040.00

Fan Dimension Information

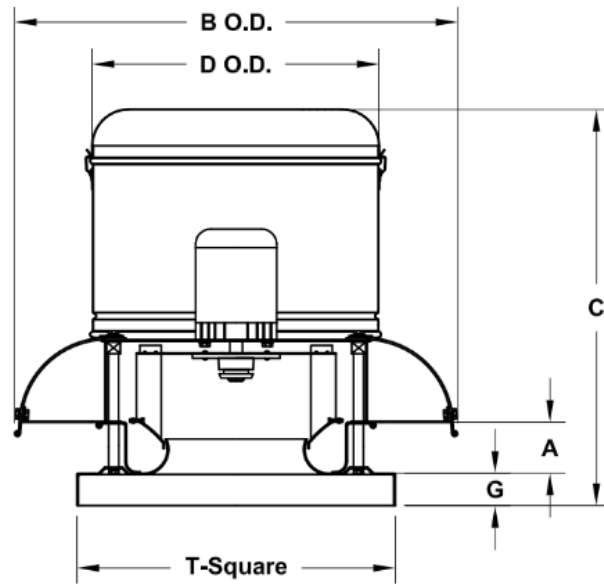

ACE-D Direct Drive Dimension Data

Fan Size	A	B	C	D	G	T Sq.	Roof Opening Square	Shipping Weight
70	1-3/4	13-5/8	13-13/16	16-3/4	2	18	13-1/2	20
90	2-1/2	18-3/4	16-13/16	16-3/4	2	18	13-1/2	28
100	2-1/2	18-3/4	16-13/16	16-3/4	2	18	13-1/2	30
120	1-7/16	28-7/16	26-9/16	20-3/8	2	20	15-1/2	67
135	1-15/16	28-7/16	27-1/16	20-3/8	2	20	15-1/2	72
150	2-13/16	32-7/8	29-3/16	23-13/16	2	24	19-1/2	90

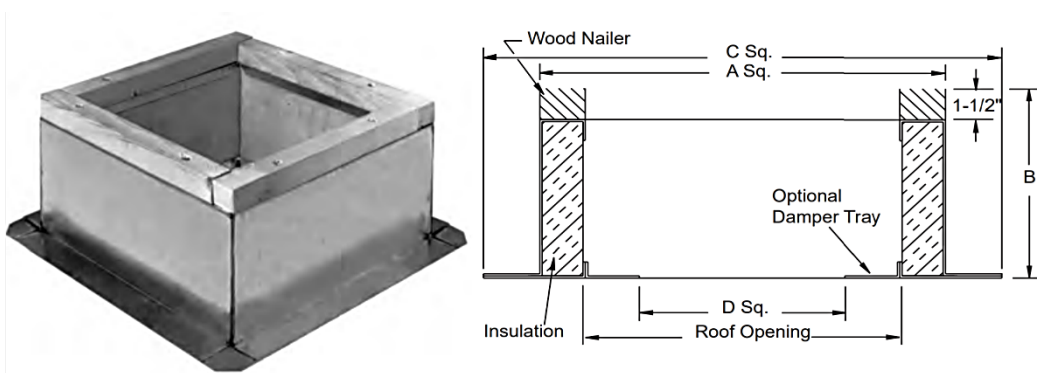

Roof Curb Dimension Data

Fan Size	A Sq	B	C Sq	D Sq	Roof Opening Square	Curb Size to Order
70-100	16-1/2	9-1/2	20-1/2	9-3/4	13-1/2	17 x 17
120-135	18-1/2	9-1/2	22-1/2	11-3/4	15-1/2	19 x 19
150	22-1/2	9-1/2	26-1/2	15-3/4	19-1/2	23 x 23

Ceiling Fans



Gemini

Features:

- Direct Drive
- Gravity Backdraft Damper included
- Speed Controller Pricing on page 22
- Inline Kits available for GC146, GC148 & GC186

Model	Motor RPM	0.00"SP CFM/Sones	0.125" SP CFM/Sones	0.250"SP CFM/Sones	0.375"SP CFM/Sones	.500"SP CFM/Sones	0.625"SP CFM/Sones	0.750"SP CFM/Sones	List Price
GC148	1075	152/2.5	142/2.5	132/2.5	120/2.5	108/3.0	94/3.0	78/3.5	\$365.00
GC186	1100	231/5.5	225/5.5	218/5.5	209/5.5	199/5.0	186/5.0	170/5.0	\$470.00
GC542	1600	391/5.5	377/5.5	361/5.5	340/5.5	314/5.5	285/5.0	248/4.5	\$645.00
GC622	1400	501/3.5	486/3.5	461/3.0	433/3.0	392/3.0	339/3.0	-	\$725.00

Model	Inline Kit
GC148	\$70.00
GC186	\$70.00

Model	Speed Controller
GC148	5 amp
GC186	5 amp
GC542	5 amp
GC622	5 amp

**Pricing on page 22*

Fan Accessories

Speed Controller



5 amp

10 amp

Features:

- Available for Direct Drive units
- Can be mounted remotely or at the unit
- Used to adjust unit to desired capacity

Control Mode	List Price
5 amp	\$130.00
10 amp	\$220.00

Roof Curbs



Features:

- 12" high
- Rigid insulation
- Nominal 2" x 2" wood nailer

Curb O.D.	List Price
14 x 14	\$175.00
16 x 16	\$185.00
17 x 17	\$190.00
19 x 19	\$210.00
23 x 23	\$250.00
29 x 29	\$350.00



Wall & Roof Caps

Wall Caps

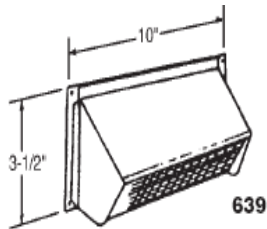

639

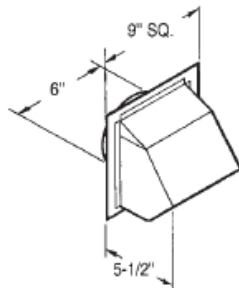

641

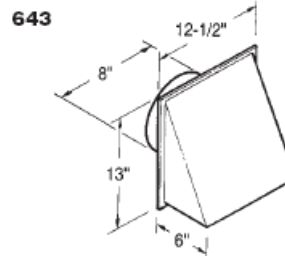

643

Item	List Price
639	\$73.00
641	\$105.00
643	\$180.00

- Steel baked black enamel finish
- Spring-loaded backdraft damper and built-in alum bird screen
- For 3 1/2" x 10" duct
- Aluminum – natural finish
- Built-in backdraft damper
- For 6" round duct
- Aluminum – natural finish
- Built-in backdraft damper
- For 8" round duct

Roof Caps

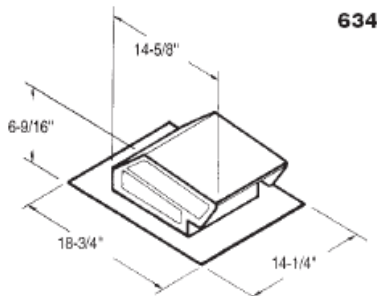

634

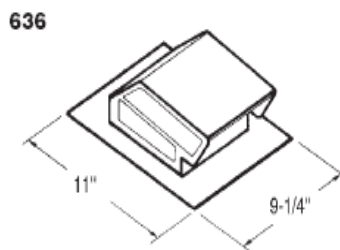

636

Item	List Price
634	\$80.00
636	\$46.00

- Steel black electrically bonded epoxy finish
- Built-in backdraft damper & birdscreen
- For 10-2/4" x 10 3/4" or up to 10" round
- Steel black electrically bonded epoxy finish
- Built-in backdraft damper & birdscreen
- For 4" round duct

Dampers & Actuators

0110H Fire



- Features:**
- Can be mounted vertically or horizontally
 - 1-1/2 hour rated
 - Duct size – ¼”
 - 4 ¼” deep

Size W x H	List Price	Size W x H	List Price
6 x 6	\$44.00	16 x 12	\$74.00
8 x 6	\$44.00	16 x 16	\$82.00
8 x 8	\$49.00	18 x 12	\$82.00
10 x 8	\$49.00	18 x 18	\$98.00
10 x 10	\$52.00	20 x 20	\$98.00
12 x 6	\$49.00	22 x 10	\$82.00
12 x 8	\$52.00	24 x 10	\$82.00
12 x 10	\$52.00	24 x 12	\$90.00
12 x 12	\$58.00	24 x 16	\$98.00
14 x 8	\$63.00	24 x 24	\$118.00
14 x 12	\$74.00		
14 x 14	\$82.00		

0130H Fire



- Features:**
- Square damper with round transition
 - Can be mounted vertically or horizontally
 - 1-1/2 hour rated
 - Loose links available if needed

Size	List Price
6”	\$73.00
8”	\$80.00
10”	\$90.00
12”	\$95.00
14”	\$135.00
16”	\$135.00

Fusible slots	List Price
165°	\$15.00
212°	\$16.00

1020 Control



- Features:**
- 16ga galvanized steel construction
 - Blade & jamb seals

Size W x H	List Price	Size W x H	List Price
12 x 12	\$210.00	24 x 12	\$248.00
16 x 16	\$260.00	24 x 16	\$287.00
20 x 20	\$334.00	24 x 24	\$400.00
24 x 10	\$248.00	36 x 24	\$385.00

1370 Backdraft



- Features:**
- Blades are roll formed aluminum alloy
 - Polyurethane blade seals reduce backflow & noise

Size	List Price
12 x 12	\$150.00
16 x 16	\$180.00
24 x 24	\$272.00

Belimo



Model	Type	Mounting	Max Sq Ft	Voltage	List Price
LF24	Electric	External/Internal	5-7	24V	\$400.00
LF120	Electric	External/Internal	5-7	120V	\$440.00
NFB24	Electric	External/Internal	13-15	24V	\$490.00
NFBUP120	Electric	External/Internal	13-15	24-240V	\$485.00
½” SHAFT QUAD	Manual				\$21.00

Louvers & Brick Vents



1604D

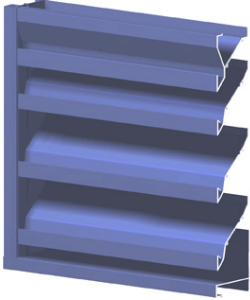

Features:

- 4" Deep Louver
- Material: Extruded Aluminum
- 45° Drainable Stationary Blade
- ½" Mesh Aluminum Birdscreen

Size	List Price
12 x 12	\$200.00
16 x 16	\$245.00
24 x 12	\$240.00
24 x 24	\$330.00
36 x 24	\$430.00



168EX



Features:

- Brick Vent
- Material: Extruded Aluminum
- ½" Mesh Aluminum Birdscreen

Size	List Price
16½ x 7½	\$240.00

Access Doors



Cam



Features:

- Door Panel – 24ga Galvanized Steel
- Frame – 22ga Galvanized Steel
- Insulation – 1" Fiberglass

Size	List Price
8 x 8	\$40.00
10 x 10	\$44.00
12 x 12	\$49.00
14 x 14	\$58.00
16 x 16	\$72.00
18 x 18	\$82.00
24 x 24	\$115.00

Vibration Isolators



**Model FS-SA
Spring Mount**



**Model SHRB
Spring Hangers**



**Model SH-SN
Spring Flex Hangers**

Floor Mounted, Spring Type FS-SA				Hangers, Spring Type SHRB				Hangers, Spring Type SH-SN			
Type	Height	Max Load lbs.	List Price	Type	Height	Max Load lbs.	List Price	Type	Height	Max Load lbs.	List Price
FS-SA-45	4 ½"	50	\$80.00	SHRB-2N-50	8"	50	\$137.00	SH-SN-15	4 ½"	23	\$31.00
FS-SA-75	4 ½"	80	\$80.00	SHRB-2N-100	8"	80	\$137.00	SH-SN-45	4 ½"	40	\$31.00
FS-SA-115	4 ½"	130	\$80.00	SHRB-2N-200	8"	130	\$137.00	SH-SN-60	4 ½"	65	\$31.00
FS-SA-200	4 ½"	210	\$80.00	SHRB-2N-200	8"	210	\$137.00	SH-SN-100	4 ½"	90	\$31.00
FS-SA-260	4 ½"	300	\$80.00	SHRB-2N-300	8"	300	\$137.00	SH-SN-150	4 ½"	185	\$31.00
FS-SA-300	4 ½"	370	\$80.00	SHRB-2N-400	8"	370	\$137.00	SH-1N-200	4 ½"	210	\$87.00
								SH-1N-300	4 ½"	300	\$87.00
								SH-1N-300	4 ½"	370	\$87.00

Vibration Isolators



Model NH
Rubber-In-Shear Hangers



Model RD
Rubber-In-Shear Mounts

Hangers, Rubber-In-Shear Type NH				Floor Mounted, Rubber-In-Shear Type RD			
Type	Height	Max Load lbs.	List Price	Type	Height	Max Load lbs.	List Price
NH-1-30	3"	30	\$21.00	RD-1-Blue	1 ¼"	30	\$32.00
NH-1-60	3"	40	\$21.00	RD-1-Black	1 ¼"	40	\$32.00
NH-1-100	3"	70	\$21.00	RD-1-Red	1 ¼"	70	\$32.00
NH-1-150	3"	120	\$21.00	RD-1-Green	1 ¼"	115	\$32.00
NH-1-200	4"	165	\$21.00	RD-2-Blue	1 ¾"	130	\$45.00
NH-1-300	4"	235	\$45.00	RD-2-Black	1 ¾"	165	\$45.00
NH-1-400	4"	375	\$45.00	RD-2-Red	1 ¾"	235	\$45.00
NH-1-700	4"	572	\$45.00	RD-2-Green	1 ¾"	375	\$45.00

Shear Flex Pads



Features:

- Material: Special Rubber
- Extremely High Deflection Rate
- Alternately Raised Ribs provide effective vibration isolation in both high & low load ranges
- Max Load: 60lbs
- Load Range: 15-55 psi

Size	List Price
18" x 18" x 3/8"	\$100.00